

Serial No.	H-V015-E-7
------------	------------

## Stop valve

<b>User's Manual</b>
----------------------





### Contents



- (1) Be sure to read the following warranty clauses of our product ..... 1
- (2) General operating instructions ..... 2
- (3) General instructions for transportation, unpacking and storage ..... 3
- (4) Name of parts ..... 4
- (5) Working pressure vs. temperature ..... 6
- (6) Installation procedure ..... 7
- (7) Operating procedure ..... 10
- (8) Disassembly and assembly procedure for parts replacement ..... 11
- (9) Inspection items ..... 11
- (10) Troubleshooting ..... 12
- (11) Handling of residual and waste materials ..... 12

This user's guide contains information important to the proper installation, maintenance and safe use of an ASAHI AV Product. Please store this manual in an easily accessible location.

<Warning & Caution Signs>

 Warning	<p>This symbol reminds the user to take caution due to the potential for serious injury or death.</p>
 Caution	<p>This symbol reminds the user to take caution due to the potential for damage to the valve if used in such a manner.</p>

<Prohibited & Mandatory Action Signs>

	<p>Prohibited: When operating the valve, this symbol indicates an action that should not be taken.</p>
	<p>Mandatory action: When operating the valve, this symbol indicates mandatory actions that must be adhered to.</p>

**(1) Be sure to read the following warranty clauses of our product**

- Always observe the specifications of and the precautions and instructions on using our product.
- We always strive to improve product quality and reliability, but cannot guarantee perfection. Therefore, should you intend to use this product with any equipment or machinery that may pose the risk of serious or even fatal injury, or property damage, ensure an appropriate safety design or take other measures with sufficient consideration given to possible problems. We shall assume no responsibility for any inconvenience stemming from any action on your part without our written consent in the form of specifications or other documented approval.
- The related technical documents, operation manuals, and other documentation prescribe precautions on selecting, constructing, installing, operating, maintaining, and servicing our products. For details, consult with our nearest distributor or agent.
- Our product warranty extends for one and a half years after the product is shipped from our factory or one year after the product is installed, whichever comes first. Any product abnormality that occurs during the warranty period or which is reported to us will be investigated immediately to identify its cause. Should our product be deemed defective, we shall assume the responsibility to repair or replace it free of charge.
- Any repair or replacement needed after the warranty period ends shall be charged to the customer.
- The warranty does not cover the following cases:
  - (1) Using our product under any condition not covered by our defined scope of warranty.
  - (2) Failure to observe our defined precautions or instructions regarding the construction, installation, handling, maintenance, or servicing of our product.
  - (3) Any inconvenience caused by any product other than ours.
  - (4) Remodeling or otherwise modifying our product by anyone other than us.
  - (5) Using any part of our product for anything other than the intended use of the product.
  - (6) Any abnormality that occurs due to a natural disaster, accident, or other incident not stemming from something inside our product.

**(2) General Operating Instructions**



Warning

- Using a positive-pressure gas with our plastic piping may pose a dangerous condition due to the repellent force particular to compressible fluids even when the gas is under similar pressures used for liquids. Therefore, be sure to take the necessary safety precautions such as covering the piping with protective material. For inquiries, please contact us. For conducting a leak test on newly installed piping, be sure to check for leaks under water pressure. If absolutely necessary to use a gas in testing, please consult your nearest service station beforehand.



Caution



- Do not step on or apply excessive weight on valve. (It can be damaged.)
- Do not use the valve in conditions where the fluid may have crystallized. (The valve will not operate properly.)
- Keep the valve away from excessive heat or fire. (It can be damaged, or destroyed.)
- Always operate the valve within the pressure vs. temperature range. (The valve can be damaged or deformed by operating beyond the allowable range.)
- Allow sufficient space for maintenance and inspection.
- Select a valve material that is compatible with the media. For chemical resistance information, refer to “CHEMICAL RESISTANCE ON ASAHI AV VALVE”. (Some chemicals may damage incompatible valve materials.)
- Keep the valve out of direct sunlight, water and dust. Use cover to shield the valve. (The valve will not operate properly.)
- Perform periodic maintenance. (Leakage may develop due to temperature changes or periods of prolonged storage, rest, or operation.)

## (3) General Instructions for Transportation, Unpacking and Storage



Warning

- When suspending and supporting a valve, take care and do not stand under a suspended valve.



Caution

- This valve is not designed to handle impacts of any kind. Avoid throwing or dropping the valve.

- Avoid scratching the valve with any sharp object.

- Do not over-stack cardboard shipping boxes. Excessively stacked packages may collapse.

- Avoid contact with any coal tar creosote, insecticides, vermicides or paint.

(These chemicals may cause damage to the valve.)

- When transporting a valve, do not carry it by the handle.



- Store products in their corrugated cardboard boxes. Avoid exposing products to direct sunlight, and store them indoors (at room temperature). Also avoid storing products in areas with excessive temperatures. (Corrugated cardboard packages become weaker as they become wet with water or other liquid. Take care in storage and handling.)

- After unpacking the products, check that they are defect-free and meet the specifications.

(4) Name of parts

Nominal size, 15mm~50mm (1/2"~2")

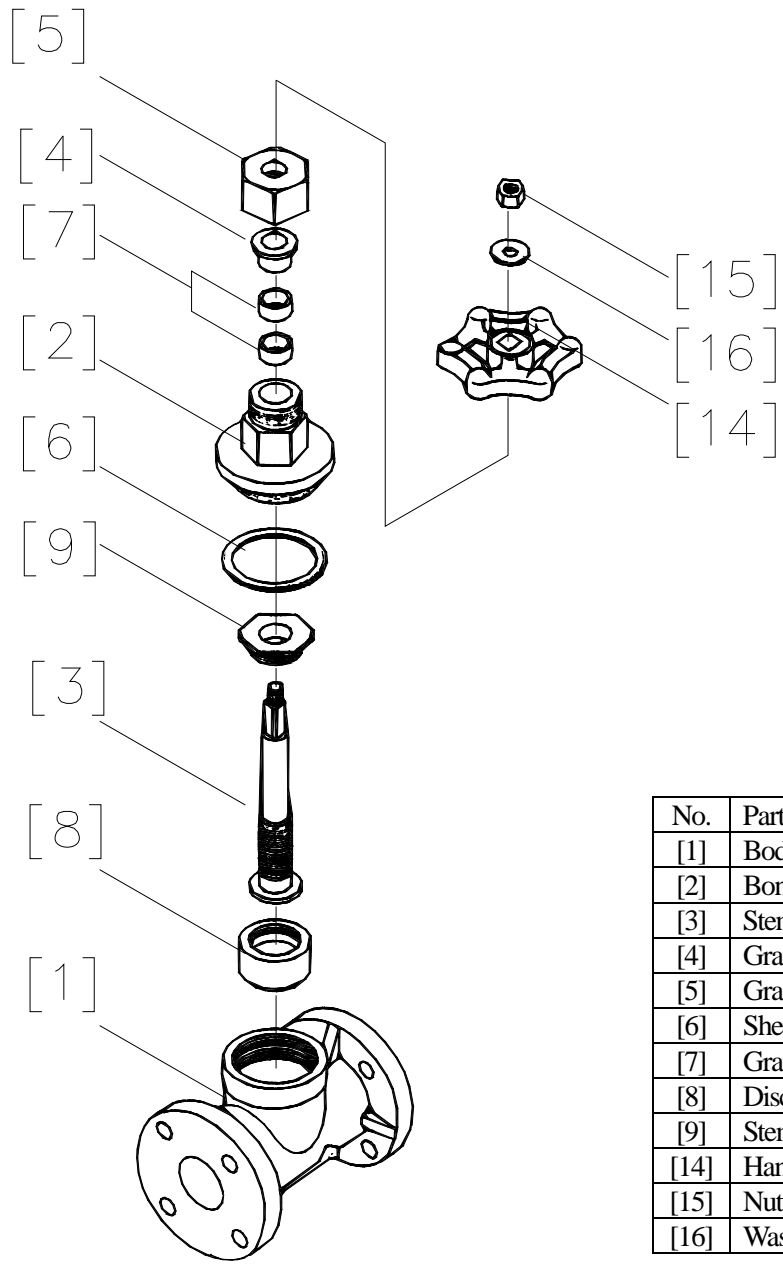

No.	Parts of name
[1]	Body
[2]	Bonnet
[3]	Stem
[4]	Grand
[5]	Grand nut
[6]	Sheet gasket
[7]	Grand packing
[8]	Disc
[9]	Stem holder
[14]	Hand wheel
[15]	Nut(A)
[16]	Washer

Nominal size, 65mm~100mm (2 1/2"~4")

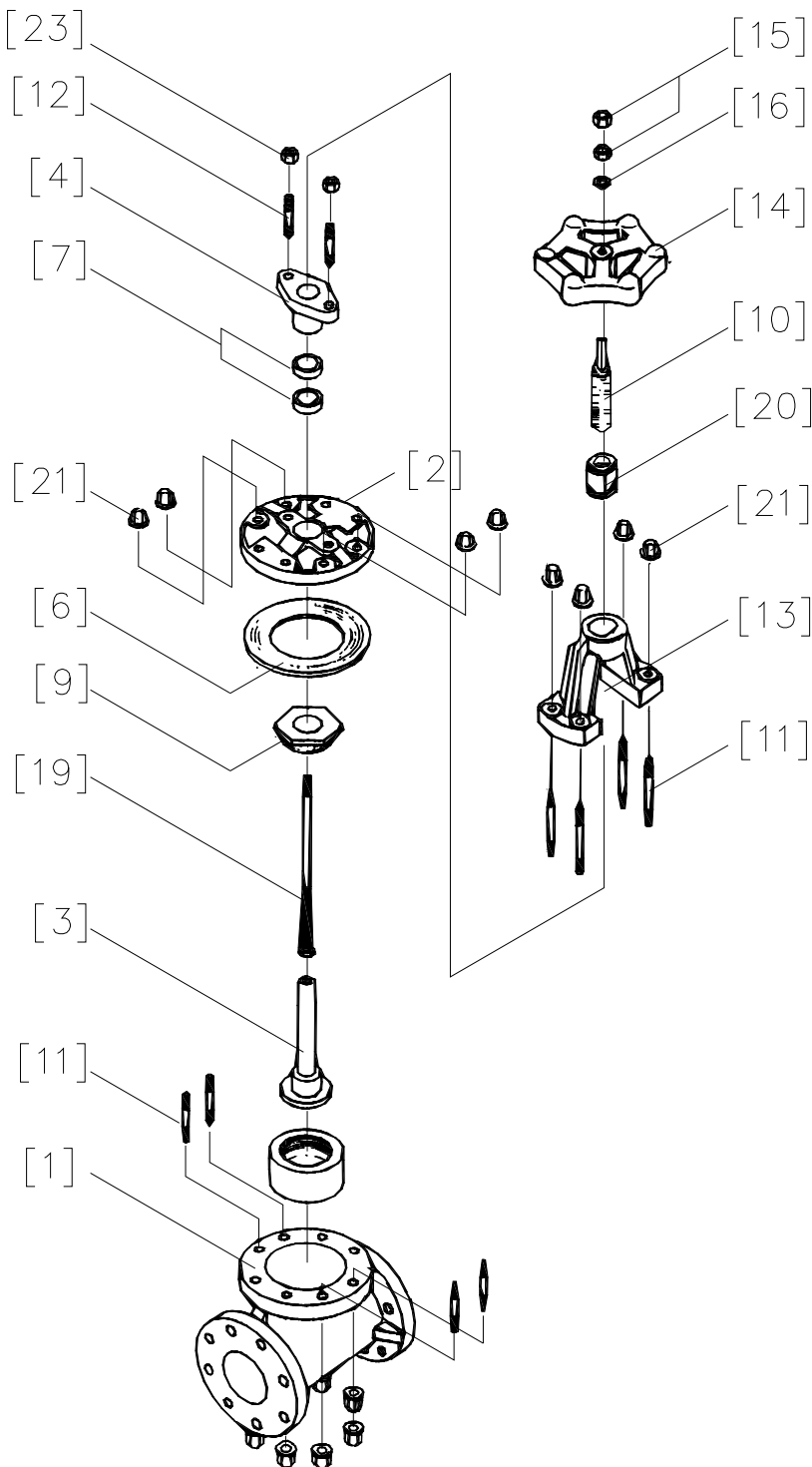

No.	Parts of name
[1]	Body
[2]	Bonnet
[3]	Stem
[4]	Grand
[6]	Sheet gasket
[7]	Grand packing
[8]	Disc
[9]	Stem holder
[10]	Stem with trapezoid screw
[11][21]	Bolt • nut
[12][23]	Stud bolt • nut
[13]	Support of stem
[14]	Hand wheel
[15]	Nut(A)
[16]	Washer
[20]	Inserted metal
[23]	Lock nut

(5) Working pressure vs. temperature

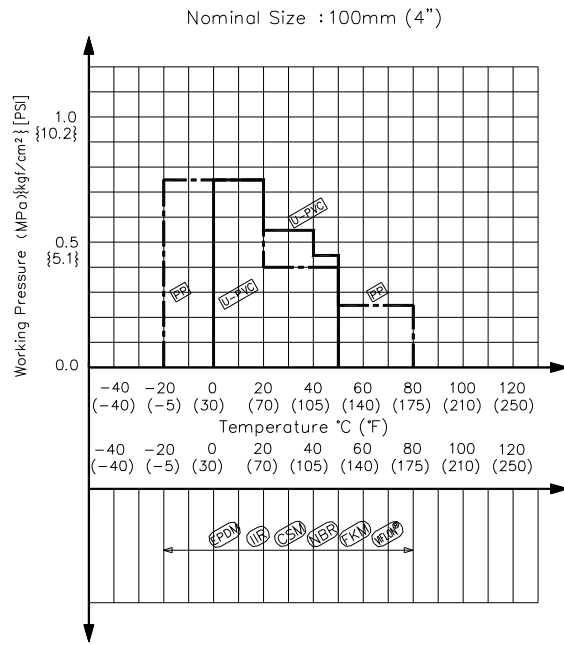
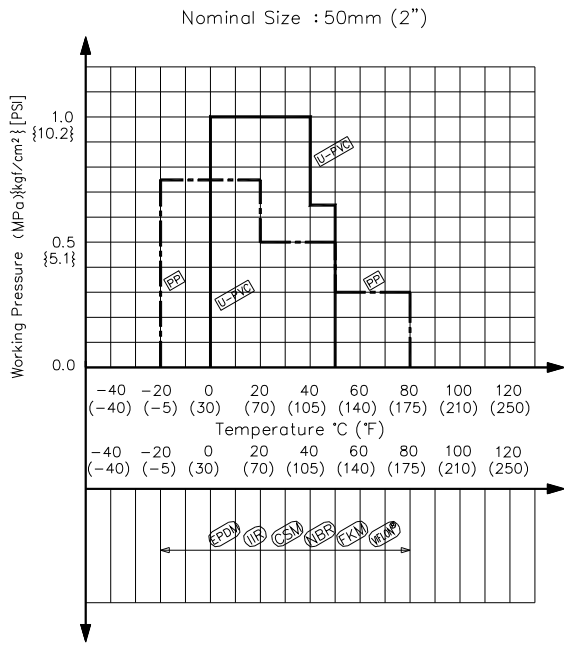
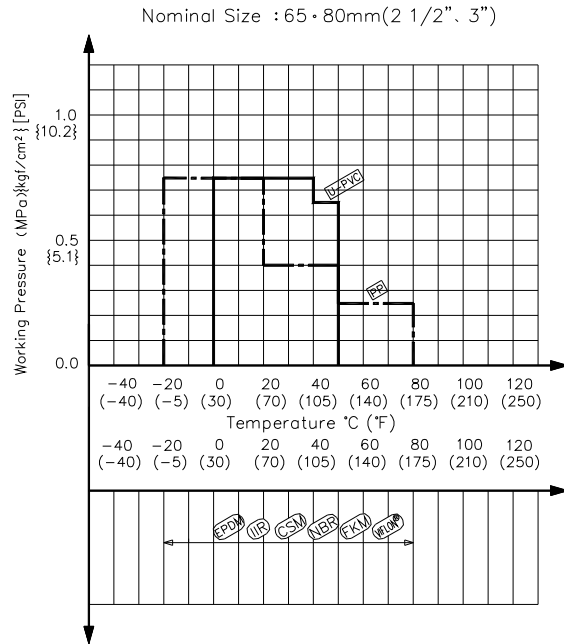
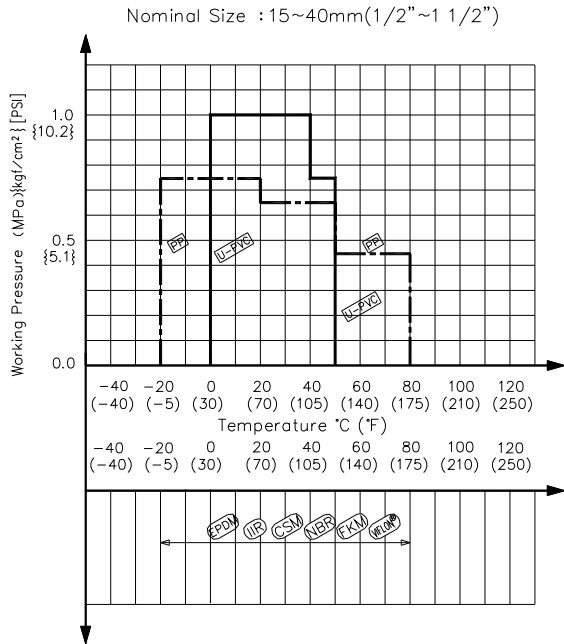

**(6) Installation procedure**

**Warning**

- When suspending and supporting a valve, take care and do not stand under a suspended valve.
- Be sure to conduct a safety check on all hand and power tools to be used before beginning work.
- Wear protective gloves and safety goggles as fluid remain in the valve even if the pipeline is empty. (You may be injured.)

**Caution**

- When installing a pipe support by means of a U-band or something similar, take care not to over-tighten. (Excessive force may damage the pipe.)
- When installing pipes and valves, ensure that they are not subjected to tension, compression, bending, impact, or other excessive stress.
- The valve can be applied to both horizontal and vertical piping.  
Install the piping while matching the arrow of the Body to the flow direction of the fluid.
- Take care not to over-tighten the Union Nut. (The valve can be damaged.)
- Do not use the pipe wrench. (The valve can be damaged.)

**Flanged type** (Material : PVC,PP)

**Caution**

- Use flat faced flanges for connection to AV Valves.
- Ensure that the mating flanges are of the same standards.
- Be sure to use sealing gaskets (AV Gasket), bolts, nuts, and washers and tighten them to specified torques. (When a non-AV gasket is used, a different tightening torque specification should be followed.)

- Necessary items
- Torque wrench
  - AV gasket
  - Spanner wrench
  - Bolt, Nut, Washer (For many flanges specification)



Procedure

- 1) Set the AV gasket between the flanges.
- 2) Insert washers and bolts from the pipe side, insert washers and nuts from the valve side, then temporarily tighten them by hand.



- The parallelism and axial misalignment of the flange surface should be under the values shown in the following table to prevent damage the valve.  
(A failure to observe them can cause destruction due to stress application to the pipe)

Unit : mm (inch)

Nom. Size	Axial misalignment	Parallelism (a-b)
15-32mm (1/2"-1 1/4")	1.0 (0.04)	0.5 (0.02)
40- 80mm (1 1/2", 3")	1.0 (0.04)	0.8 (0.03)
100mm (4")	1.0 (0.04)	1.0 (0.04)

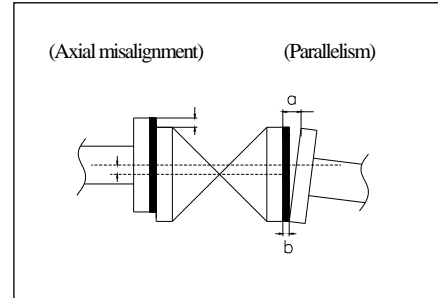

- 3) Using a torque wrench, tighten the bolts and nuts gradually to the specified torque in a diagonal manner.  
(Refer to fig.1.)

Recommended torque value

Unit: N·m [kgf·cm] [lb·inch]

Nom. Size	15-20mm (1/2"-3/4")	25-40mm (1"-1 1/2")	50, 65 mm (2", 2 1/2")	80, 100 mm (3", 4")
PTFE·PVDF coated	17.5 {179} [155]	20.0 {204} [177]	22.5 {230} [230]	30.0 {306} [266]
Rubber	8.0 {82} [71]	20.0 {204} [177]	22.5 {230} [230]	30.0 {306} [266]



- Tighten the bolts and nuts gradually with a torque wrench to the specified torque level in a diagonal manner.

Caution

Fig. 1

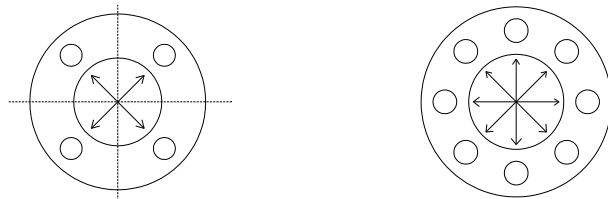

Threaded type (Material : PVC,PP)

Caution

- Avoid excessive tightening. (The valve can be damaged.)



- Make sure that the threaded connections are plastic x plastic. (Metallic thread can cause damage.)

- Wrap the threaded joints on our plastic piping with sealing tape. Using a liquid sealing agent or liquid gasket may cause stress cracks (Environmental Stress Cracking). Our product warranty shall not apply in case of said use, even when said use is unavoidable.

## Necessary items

● Sealing tape

● Strap wrench

● Spanner wrench

Procedure

- 1) Wind a sealing tape around the external thread of joint, leaving the end (about 3mm) free.
- 2) Tighten the external thread of the joint and the body [1] lightly by hand.
- 3) Using a strap wrench, screw it in by turning 90° -180° carefully without damaging it.

Socket type (Material : PVC)

Warning

- When using an adhesive, ventilate the space sufficiently, prohibit the use of a fire in the vicinity, and do not inhale adhesive vapors directly.



- If an adhesive gets into contact with your skin, wash it off immediately. If you feel sick or find any anomaly, receive a physician's diagnosis and take appropriate measures promptly.



Caution

- Take care in doing work at low temperatures. Solvent vapors are hard to evaporate and are likely to remain. (Solvent cracks may occur, damaging the equipment.) After assembling the piping system, open both ends of the piping and use a fan (of the Low-Voltage Type) or something similar to ventilate the space, thus removing the solvent vapors.



- Use the appropriate Asahi AV cement.

- Conduct a water test at least 24 hours after joining the pipes with an adhesive/cement.

## Necessary items

● Adhesive for hard vinyl chloride pipes

● Strap wrench

## Procedure

- 1) Clean the body [1] by wiping with the waste cloth.
- 2) Apply adhesive evenly to the body [1] and the pipe spigot.



Caution

- Do not apply more adhesives than necessary. (The valve can be damaged due to solvent cracking.)

### Adhesive quantity (guideline)

Nom. Size	15mm (1/2")	20mm (3/4")	25mm (1")
Quantity (g)	1.0	1.3	2.0

- 3) After applying adhesive, insert the pipe quickly to the body [1] and leave it alone for at least 60 seconds.
- 4) Wipe away overflowing adhesive.

## (7) Operating Procedure



Caution

- Do not exert excessive force in closing the valve.





- The installed valve must never be opened or closed when foreign matter such as sand is present in the pipeline.

- Do not use the valve to fluid containing slurry. (The valve will not operate properly.)



- When operating the handle, be sure to do so with your hand. (Using a tool may damage the handle.)

- Open and close the valve by rotating the hand wheel.
- The top of the travel stop will be flush with the top of the hand wheel when the valve is fully closed.

## (8) Disassembly and assembly procedure for parts replacement

  - Be sure to conduct a safety check on all hand and power tools to be used before beginning work.  
 Warning - Wear protective gloves and safety goggles as fluid remain in the valve even if the pipeline is empty.  
 (You may be injured.)

 - Do not change or replace valve parts under line pressure.

  - Do not use the pipe wrench. (The valve can be damaged.)  
 Caution

Necessary items

- Torque wrench
- Spanner wrench
- Protective gloves
- Goggles
- Bolt (M4, M5, M6, M8)
- Strap wrench

<Disassembly>

- 1) Drain fluid completely from the pipeline.
- 2) Turn handle of valve clockwise until it stops. (Do not force it.)

<Nominal size : 15-50mm(1/2"-2")>

- 3) Loosen the bonnet [2] and release the body [1].
- 4) Release the nut (A) [15] and remove the handle wheel [14].
- 5) Loosen the gland nut [5] and remove the grand packing [7].
- 6) Loosen the stem [3] and remove from the bonnet [2].



<Nominal size : 65-100mm(2 1/2"-4")>

- 3) Loosen the bolt·nut [11] and remove the bonnet [2] from the body [1].
- 4) Remove the nut (A) [15], then put up the hand wheel [14].
- 5) Remove the stem with the trapezoid screw [10] from the support of stem [13].
- 6) Loosen the stud bolt·nut [12], then remove the grand packing [7].
- 7) Loosen the stem [3] and remove from the bonnet [2].

<Assembly>

- 1) The produce of assembly is the almost reverse of its disassembly.
- 2) After assembly, make sure that the valve can be fully opened and closed smoothly.

## (9) Inspection items

  - Perform periodic maintenance. (Leakage may develop due to temperature changes or over periods of prolonged storage, rest or operation.)  
 Caution



○ Inspect the follow items ;

(1)	Existence of scratches, cracks, deformation, and discoloring.
(2)	Existence of leakage from the valve to the outside.
(3)	Existence of leakage when the valve is opened fully at right or left.

**(10) Troubleshooting**

Problem	Cause	Treatment
Fluid is leaking past the fully closed position.	Solid particles have lodged in the valve.	Clear the solid particles from the valve.
	The seat and disc are scratched.	Replace the seat and disk with new one.
The handle spins freely.	The stem is broken.	Disassemble bonnet and replace the stem.
	The stem holder is broken.	Disassemble bonnet and replace the stem.
Valve leaks between body and bonnet.	Bonnet bolts have loosened.	Re-tighten bolts & nuts.
	Media has crystallized	Disassemble and clean on a regular basis.

**(11) Handling of residual and waste materials**



 - Make sure to consult a waste treatment dealer for recommendations on the proper disposal of plastic valves. (Poisonous gas is generated when the valve is burned improperly.)

Stop valve

ASAHI YUKIZAI CORPORATION

Distributor

<http://www.asahi-yukizai.co.jp/en/>